

# 取付管布設標準図

## 取付管布設標準図 S=1:20

平面図

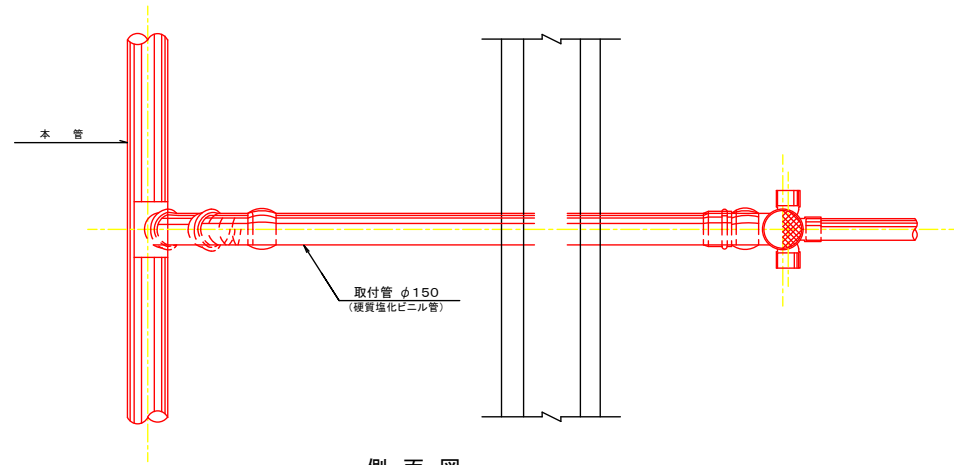

側面図  
横型

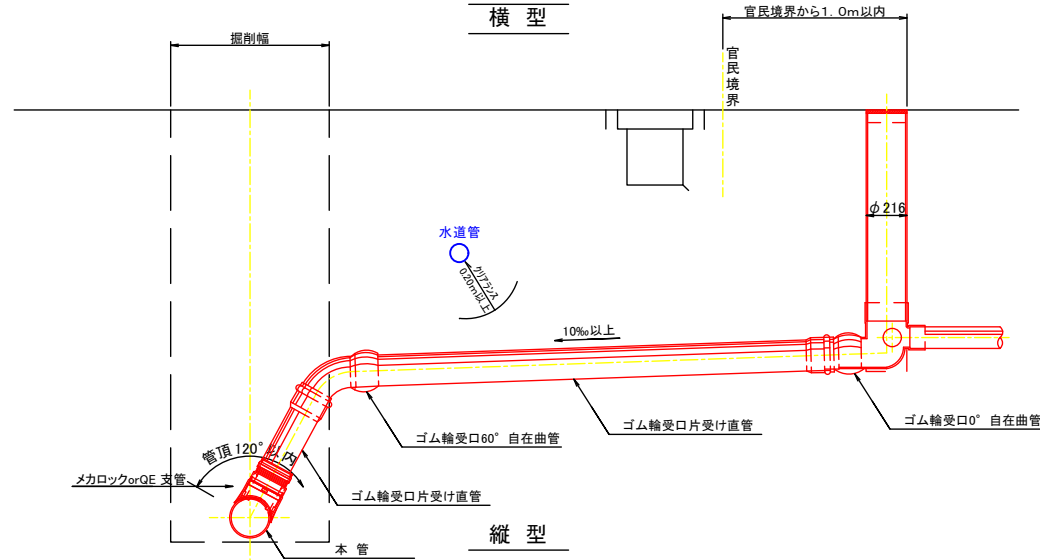

縦型

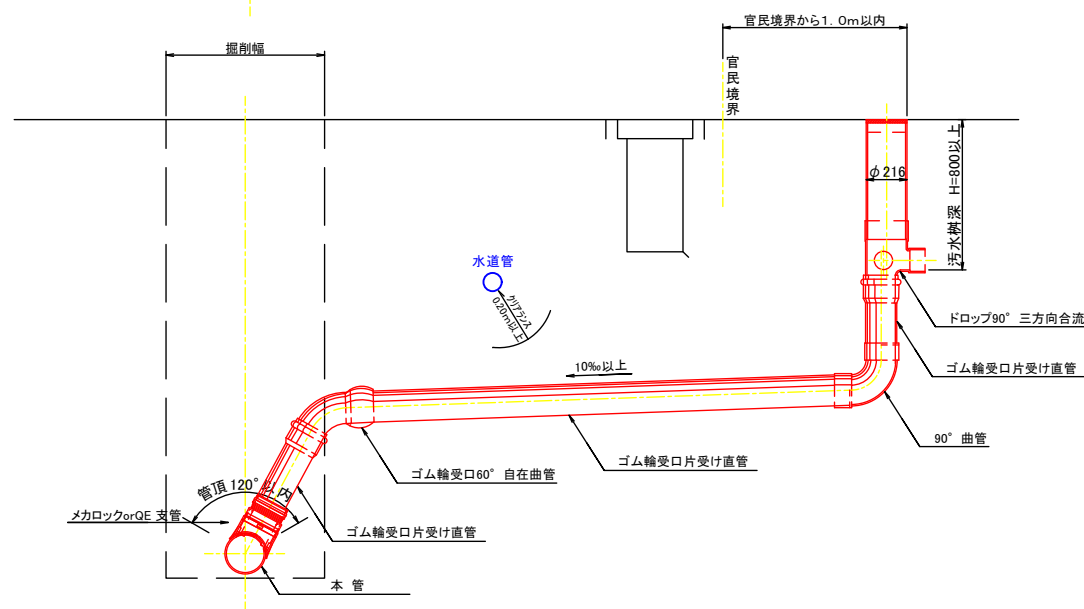

## 汚水樹標準図 S=1:10

平面図

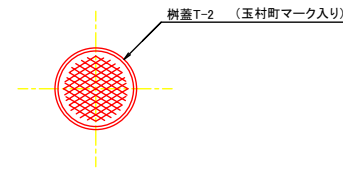

縦型90度三方向合流

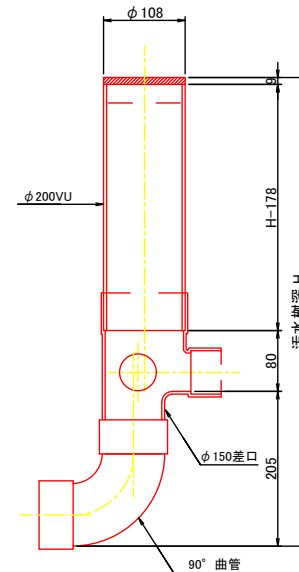

横型90度三方向合流

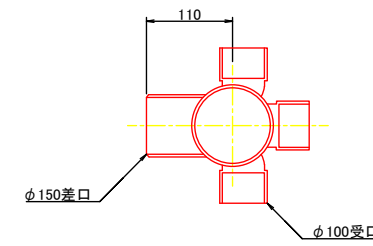
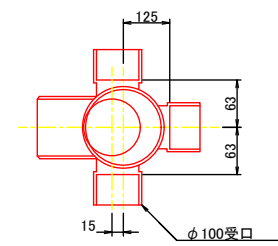
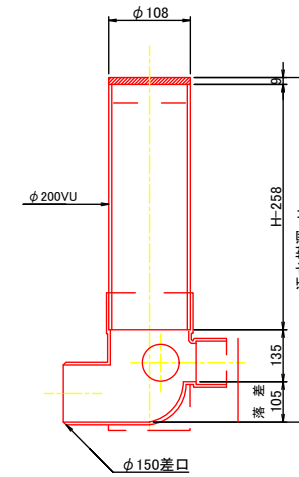

## 取付管開削標準図 S=1:40

町道舗装

掘削 埋戻し

